

# Stûv 21 double face

## Technical sheet

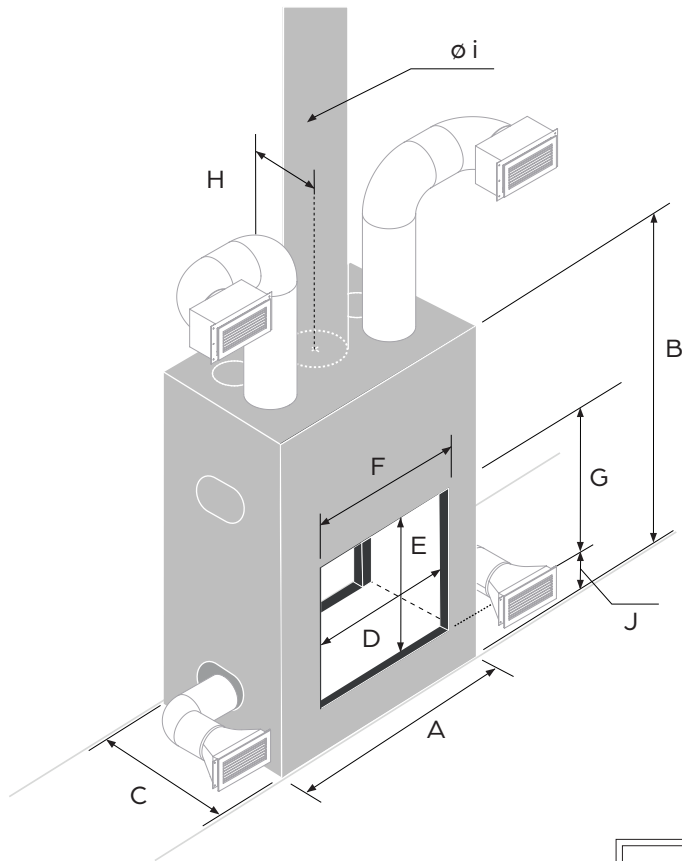

### ADVANTAGES

- Hybrid – Ambiance fire or auxiliary heating
- 
- Versatile convection system
- 
- Can be connected to outside air
- 
- Accessible mechanical components
- 
- High heating power
- 
- Easy to light
- 
- Generates little ash
- 
- Minimalist design
- 
- Wide view of the fire
- 
- Easy to clean

\*These nominal heat outputs were obtained according to a European testing protocol.  
 For additional information on powers, please see: <https://stuvamerica.com/en/inspirations/tips-and-techniques/power-btu/>  
 Dimensions for information only. See the installation manuals for details.

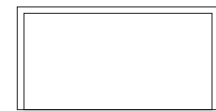
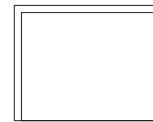
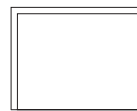

Size	21-85 DF	21-95 DF	21-125 DF
Maximum length of logs	24"	28"	40"
Nominal heat output*	48 000 BTU/h	50 000 BTU/h	61 000 BTU/h
Heating surface area	1 400 ft <sup>2</sup>	1 600 ft <sup>2</sup>	1 800 ft <sup>2</sup>
Firebox size	6.5 ft <sup>3</sup>	8.4 ft <sup>3</sup>	10.6 ft <sup>3</sup>
Convection system	standard	standard	standard
Outside air duct	ø 6"	ø 6"	ø 6"
Weight	752 lb	855 lb	960 lb
A – Width	39 ¾"	43 ⅝"	55 ½"
B – Height	59 ⅛"	63 ½"	59 ⅛"
C – Depth	29 ⅝"	29 ⅝"	29 ⅝"
D – Glass width	26 ½"	30 ⅜"	42 ⅛"
E – Glass height	21 ⅙"	24 ¼"	21 ⅙"
F – Opening width	30 ¾"	34 ⅞"	46 ½"
G – Opening height	23 ¾"	26 ⅙"	23 ¾"
H – Chimney position	15 ¾"	15 ¾"	15 ¾"
i – Chimney diameter	10"	12"	12"
J – Height to opening	6 ½"	6 ½"	6 ½"

# FRAMES & FRONT PANELS



Thin edge	21-85	21-95	21-105	21-125
W	31 5/8"	35 3/16"	39 1/8"	47"
H	24 1/8"	27 1/4"	18 13/16"	24 1/8"

● StûvGrey only

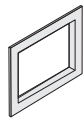

Picture type	21-85	21-95	21-105	21-125
W	35 5/8"	39 5/8"	43 1/2"	51 3/8"
H	28 1/2"	31 5/8"	23 1/4"	28 1/2"

● StûvGrey only

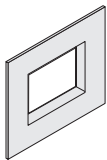

SF4	21-85	21-95	21-105	21-125
W	49 3/4"	53 3/4"	57 5/8"	65 1/2"
H	42 5/8"	45 3/4"	37 3/8"	42 5/8"

● ○ ● ● ●

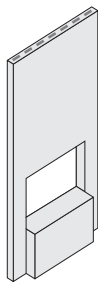

SF5	21-85 SF	21-95	21-105	21-125
W	42 5/8"	46 5/8"	50 1/2"	58 1/2"
H	81 3/4"	88"	78 3/4"	81 3/4"

● ○ ● ● ●

Integrated convection system

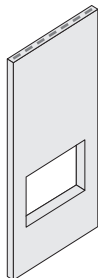

SF6	21-85	21-95	21-105	21-125
W	42 5/8"	46 5/8"	-	58 1/2"
H	81 3/4"	88"	-	81 3/4"

● ○ ● ● ●

Integrated convection system

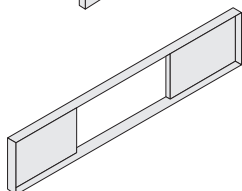

SF8	21-85	21-95	21-105	21-125
W	-	-	94 1/2"	-
H	-	-	18 7/8"	-

● StûvGrey only

Outer dimensions W = Width | H = Height

Dimensions indicated are for informative purposes only. For more details see installation manual.