

Stûv 21.2

Fiche technique

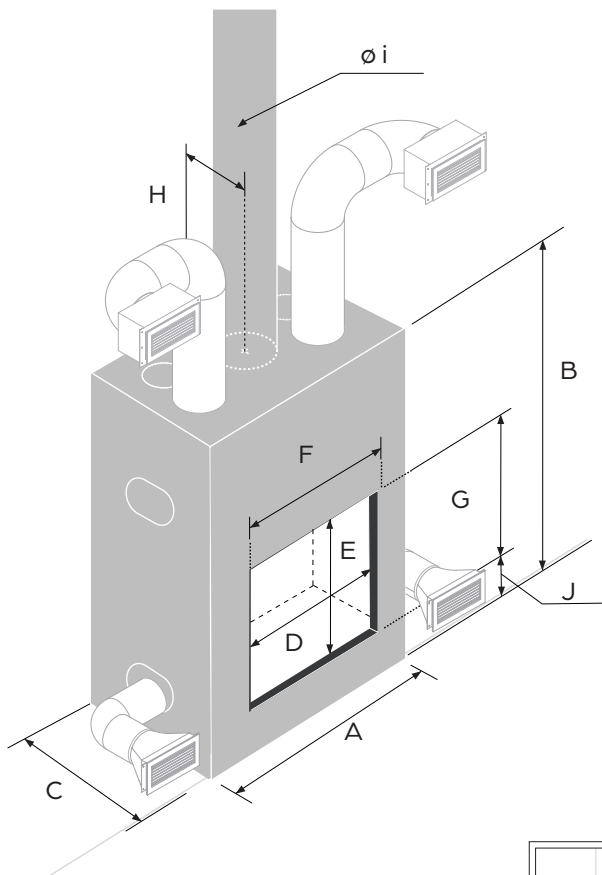

AVANTAGES

- Hybride
- Feu ambiant ou chauffage d'appoint
-
- Système de convection modulable de série
-
- Possibilité de raccordement à l'air extérieur
-
- Composants mécaniques accessibles
-
- Grande puissance de chauffe
-
- Simple à allumer
-
- Génère peu de cendres
-
- Design minimaliste
-
- Grande vue sur le feu
-
- Facile d'entretien

*Ces puissances nominales ont été obtenues selon un protocole européen. Pour de plus amples renseignements consultez : <https://stuvamerica.com/fr/inspirations/conseils-techniques/puissance-btu/>

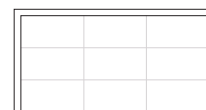
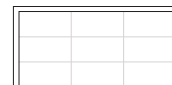
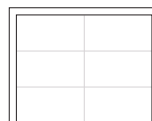
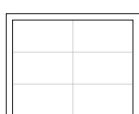

Format	21.2-85	21.2-95	21.2-105	21.2-125
Longueur max. des bûches	24"	28"	32"	40"
Puissance nominale*	44 000 BTU/h	43 000 BTU/h	65 000 BTU/h	60 000 BTU/h
Superficie de chauffage	1 400 pi ²	1 600 pi ²	1 400 pi ²	1 800 pi ²
Chambre de combustion	4.8 pi ³	6.6 pi ³	5.3 pi ³	8.4 pi ³
Système de convection	standard	standard	standard	standard
Raccordement air extérieur	ø 4-6"	ø 4-6"	ø 4-6"	ø 4-6"
Poids	665 lb	820 lb	688 lb	892 lb
A - Largeur	40"	43 7/8"	47 7/8"	55 3/4"
B - Hauteur	62 7/8"	68 1/4"	56 1/8"	62 7/8"
C - Profondeur	26 1/2"	28 1/2"	25"	27 3/4"
D - Largeur vitre	26 1/2"	30 3/8"	34 1/4"	42 1/8"
E - Hauteur vitre	21 1/16"	24 1/4"	15 3/4"	21 1/16"
F - Largeur ouverture	30 3/4"	34 7/8"	38 3/4"	46 1/2"
G - Hauteur ouverture	23 3/4"	26 15/16"	18 1/2"	23 3/4"
H - Position cheminée	10 1/2"	11 3/4"	11"	11 3/4"
i - Diamètre cheminée	8"	10"	8"	10"
J - Niveau ouverture	6 1/2"	6 1/2"	6 1/2"	6 1/2"

CADRES & DEVANTURES



fin	21-85	21-95	21-105	21-125
L	31 5/8"	35 3/16"	39 1/8"	47"
H	24 1/8"	27 1/4"	18 13/16"	24 1/8"

● StûvGrey uniquement

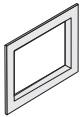

appliqué	21-85	21-95	21-105	21-125
L	35 5/8"	39 5/8"	43 1/2"	51 3/8"
H	28 1/2"	31 5/8"	23 1/4"	28 1/2"

● StûvGrey uniquement

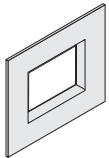

SF4	21-85	21-95	21-105	21-125
L	49 3/4"	53 3/4"	57 5/8"	65 1/2"
H	42 5/8"	45 3/4"	37 3/8"	42 5/8"

● ○ ● ● ●

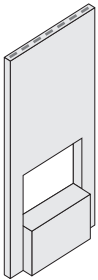

SF5	21-85 SF	21-95	21-105	21-125
L	42 5/8"	46 5/8"	50 1/2"	58 1/2"
H	81 3/4"	88"	78 3/4"	81 3/4"

● ○ ● ● ●

Système de convection intégré

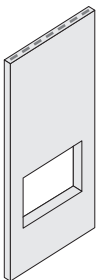

SF6	21-85	21-95	21-105	21-125
L	42 5/8"	46 5/8"	-	58 1/2"
H	81 3/4"	88"	-	81 3/4"

● ○ ● ● ●

Système de convection intégré

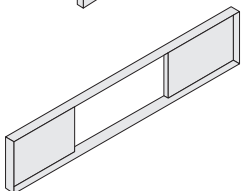

SF8	21-85	21-95	21-105	21-125
L	-	-	94 1/2"	-
H	-	-	18 7/8"	-

● StûvGrey uniquement