

Stûv 21 double face

Technical sheet



ADVANTAGES

- Hybrid – Ambiance fire or auxiliary heating
-
- Versatile convection system
-
- Can be connected to outside air
-
- Accessible mechanical components
-
- High heating power
-
- Easy to light
-
- Generates little ash
-
- Minimalist design
-
- Wide view of the fire
-
- Easy to clean

*These nominal heat outputs were obtained according to a European testing protocol.

For additional information on powers, please see: <https://stuvamerica.com/en/inspirations/tips-and-techniques/power-btu/>

Dimensions for information only. See the installation manuals for details.

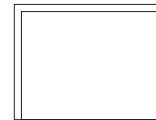
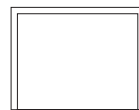
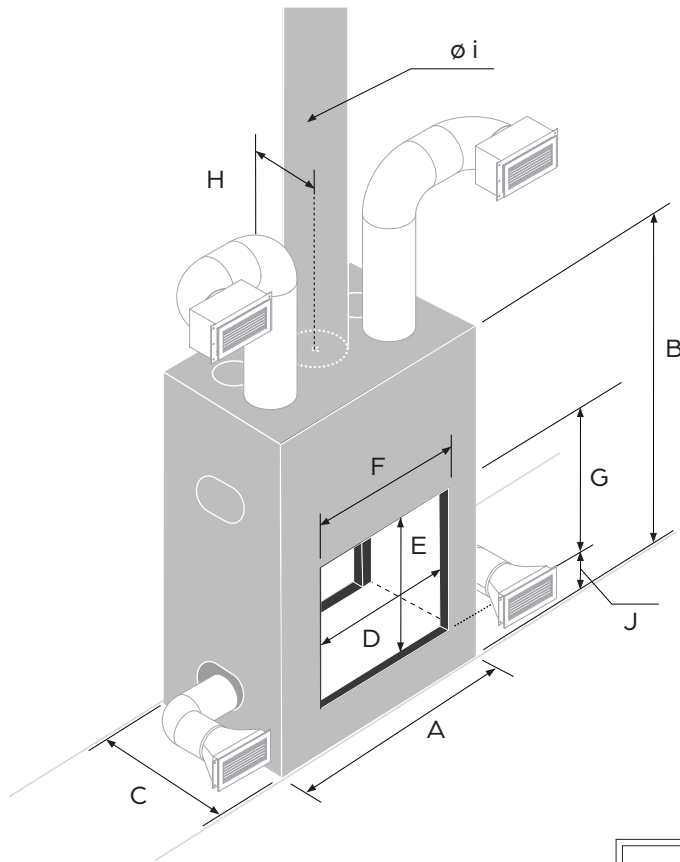

Size	21-85 DF	21-95 DF	21-125 DF
Maximum length of logs	24"	28"	40"
Nominal heat output*	48 000 BTU/h	50 000 BTU/h	61 000 BTU/h
Heating surface area	1 400 ft ²	1 600 ft ²	1 800 ft ²
Firebox size	6.5 ft ³	8.4 ft ³	10.6 ft ³
Convection system	standard	standard	standard
Outside air duct	ø 6"	ø 6"	ø 6"
Weight	752 lb	855 lb	960 lb
A – Width	39 3/4"	43 5/8"	55 1/2"
B – Height	62 7/8"	68 1/4"	62 7/8"
C – Depth	31 1/2"	31 1/2"	31 1/2"
D – Glass width	26 1/2"	30 3/8"	42 1/8"
E – Glass height	21 1/16"	24 1/4"	21 1/16"
F – Opening width	30 3/4"	34 7/8"	46 1/2"
G – Opening height	23 3/4"	26 15/16"	23 3/4"
H – Chimney position	15 3/4"	15 3/4"	15 3/4"
i – Chimney diameter	10"	12"	12"
J – Height to opening	6 1/2"	6 1/2"	6 1/2"

FRAMES & FRONT PANELS



Thin edge	21-85	21-95	21-105	21-125
W	31 ⁵ / ₈ "	35 ³ / ₁₆ "	39 ¹ / ₈ "	47"
H	24 ¹ / ₈ "	27 ¹ / ₄ "	18 ¹³ / ₁₆ "	24 ¹ / ₈ "

● StûvGrey only



Picture type	21-85	21-95	21-105	21-125
W	35 ⁵ / ₈ "	39 ⁵ / ₈ "	43 ¹ / ₂ "	51 ³ / ₈ "
H	28 ¹ / ₂ "	31 ⁵ / ₈ "	23 ¹ / ₄ "	28 ¹ / ₂ "

● StûvGrey only

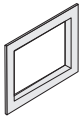

SF4	21-85	21-95	21-105	21-125
W	49 ³ / ₄ "	53 ³ / ₄ "	57 ⁵ / ₈ "	65 ¹ / ₂ "
H	42 ⁵ / ₈ "	45 ³ / ₄ "	37 ³ / ₈ "	42 ⁵ / ₈ "

● ○ ● ● ●

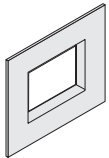

SF5	21-85 SF	21-95	21-105	21-125
W	42 ⁵ / ₈ "	46 ⁵ / ₈ "	50 ¹ / ₂ "	58 ¹ / ₂ "
H	81 ³ / ₄ "	88"	78 ³ / ₄ "	81 ³ / ₄ "

● ○ ● ● ●

Integrated convection system

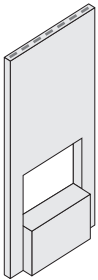

SF6	21-85	21-95	21-105	21-125
W	42 ⁵ / ₈ "	46 ⁵ / ₈ "	-	58 ¹ / ₂ "
H	81 ³ / ₄ "	88"	-	81 ³ / ₄ "

● ○ ● ● ●

Integrated convection system

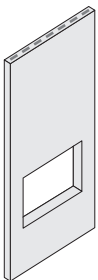

SF8	21-85	21-95	21-105	21-125
W	-	-	94 ¹ / ₂ "	-
H	-	-	18 ⁷ / ₈ "	-

● StûvGrey only

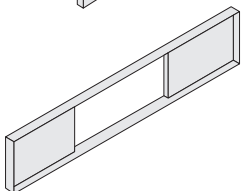

Outer dimensions W = Width | H = Height

Dimensions indicated are for informative purposes only. For more details see installation manual.