

ADVANTAGES

- Hybrid - Ambiance fire or auxiliary heating
-
- Versatile convection system
-
- Can be connected to outside air
-
- Accessible mechanical components
-
- High heating power
-
- Easy to light
-
- Generates little ash
-
- Minimalist design
-
- Wide view of the fire
-
- Easy to clean

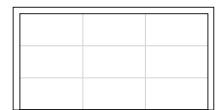
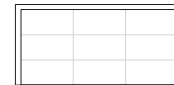
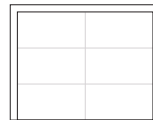
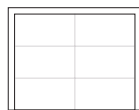

Size	21-85	21-95	21-105	21-125
Maximum length of logs	24"	28"	32"	40"
Maximum power (BTU)	48 000	55 000	48 000	60 000
Heating surface area	1 400 ft ²	1 600 ft ²	1 400 ft ²	1 800 ft ²
Firebox size	4.8 ft ³	6.6 ft ³	5.3 ft ³	8.4 ft ³
Weight	665 lb	820 lb	688 lb	892 lb
Outside air duct	ø 4-6"	ø 4-6"	ø 4-6"	ø 4-6"
Convection system	standard	standard	standard	standard
A - Width	39 11/16"	43 5/8"	47 9/16"	55 7/16"
B - Height	59"	63 3/8"	56 1/16"	59"
C - Depth	25 3/4"	27 7/8"	24 1/4"	26 7/8"
D - Glass width	26 3/8"	30 5/16"	34 1/4"	42 1/8"
E - Glass height	21 1/16"	24 3/16"	15 3/4"	21 1/16"
F - Opening width	30 3/4"	34 11/16"	38 11/16"	46 9/16"
G - Opening height	23 3/4"	26 7/8"	18 7/16"	23 3/4"
H - Chimney position	10 1/2"	11 13/16"	11 1/16"	11 3/4"
i - Chimney diameter	8"	*10"	8"	*10"
J - Height to opening	6 1/2"	6 1/2"	6 1/2"	6 1/2"
K - Width of floor protection	42 3/8"	46 5/16"	50 1/4"	58 1/8"

Stûv 21 double face

Technical sheet

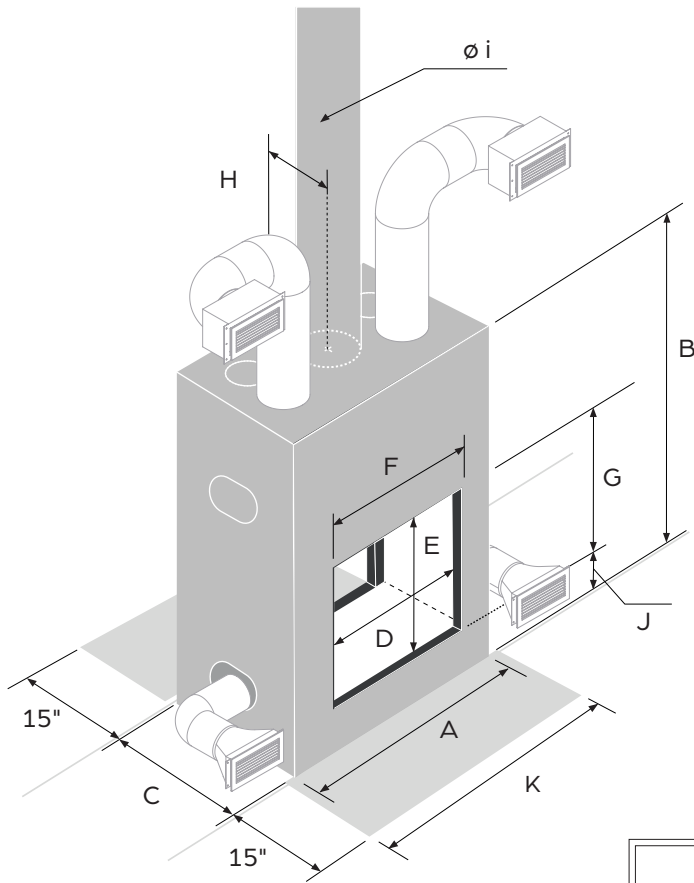

ADVANTAGES

- Hybrid – Ambiance fire or auxiliary heating
-
- Versatile convection system
-
- Can be connected to outside air
-
- Accessible mechanical components
-
- High heating power
-
- Easy to light
-
- Generates little ash
-
- Minimalist design
-
- Wide view of the fire
-
- Easy to clean

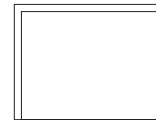
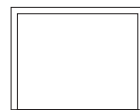

Size	21-85 DF	21-95 DF	21-125 DF
Maximum length of logs	24"	28"	40"
Maximum power (BTU)	48 000	55 000	60 000
Heating surface area	1 400 ft ²	1 600 ft ²	1 800 ft ²
Firebox size	6.5 ft ³	8.4 ft ³	10.6 ft ³
Weight	752 lb	855 lb	960 lb
Outside air duct	ø 6"	ø 6"	ø 6"
Convection system	standard	standard	standard
A – Width	39 11/16"	43 5/8"	55 7/16"
B – Height	58 3/4"	63 1/4"	58 3/4"
C – Depth	29 1/2"	29 1/2"	29 1/2"
D – Glass width	26 3/8"	30 5/16"	42 1/8"
E – Glass height	21 1/16"	24 3/16"	21 1/16"
F – Opening width	30 3/4"	34 11/16"	46 1/2"
G – Opening height	23 3/4"	26 7/8"	23 3/4"
H – Chimney position	14 3/4"	14 3/4"	14 3/4"
i – Chimney diameter	*10"	*12"	*12"
J – Height to opening	6 1/2"	6 1/2"	6 1/2"
K – Width of floor protection	42 3/8"	46 5/16"	58 1/8"

FRAMES & FRONT PANELS



Thin edge	21-85	21-95	21-105	21-125
W	31 ⁵ / ₈ "	35 ³ / ₁₆ "	39 ¹ / ₈ "	47"
H	24 ¹ / ₈ "	27 ¹ / ₄ "	18 ¹³ / ₁₆ "	24 ¹ / ₈ "

● StûvGrey only



Picture type	21-85	21-95	21-105	21-125
W	35 ⁵ / ₈ "	39 ⁵ / ₈ "	43 ¹ / ₂ "	51 ³ / ₈ "
H	28 ¹ / ₂ "	31 ⁵ / ₈ "	23 ¹ / ₄ "	28 ¹ / ₂ "

● StûvGrey only

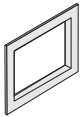

SF4	21-85	21-95	21-105	21-125
W	49 ³ / ₄ "	53 ³ / ₄ "	57 ⁵ / ₈ "	65 ¹ / ₂ "
H	42 ⁵ / ₈ "	45 ³ / ₄ "	37 ³ / ₈ "	42 ⁵ / ₈ "

● ○ ● ● ●

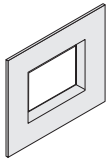

SF5	21-85 SF	21-95	21-105	21-125
W	42 ⁵ / ₈ "	46 ⁵ / ₈ "	50 ¹ / ₂ "	58 ¹ / ₂ "
H	78 ³ / ₄ "	86"	78 ³ / ₄ "	78 ³ / ₄ "

● ○ ● ● ●

Integrated convection system

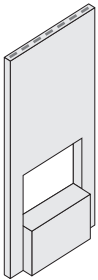

SF6	21-85	21-95	21-105	21-125
W	42 ⁵ / ₈ "	46 ⁵ / ₈ "	-	58 ¹ / ₂ "
H	78 ³ / ₄ "	86"	-	78 ³ / ₄ "

● ○ ● ● ●

Integrated convection system

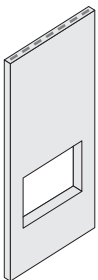

SF8	21-85	21-95	21-105	21-125
W	-	-	94 ¹ / ₂ "	-
H	-	-	18 ⁷ / ₈ "	-

● StûvGrey only

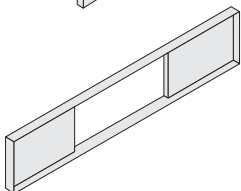

Outer dimensions W = Width | H = Height

Dimensions indicated are for informative purposes only. For more details see installation manual.